

4m Flange Plated Lighting Column (Bolt Down) - Street Lamp Post Galvanised Steel (76mm Shaft/140mm Base)

£232.00

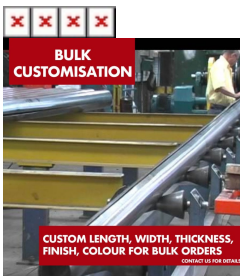

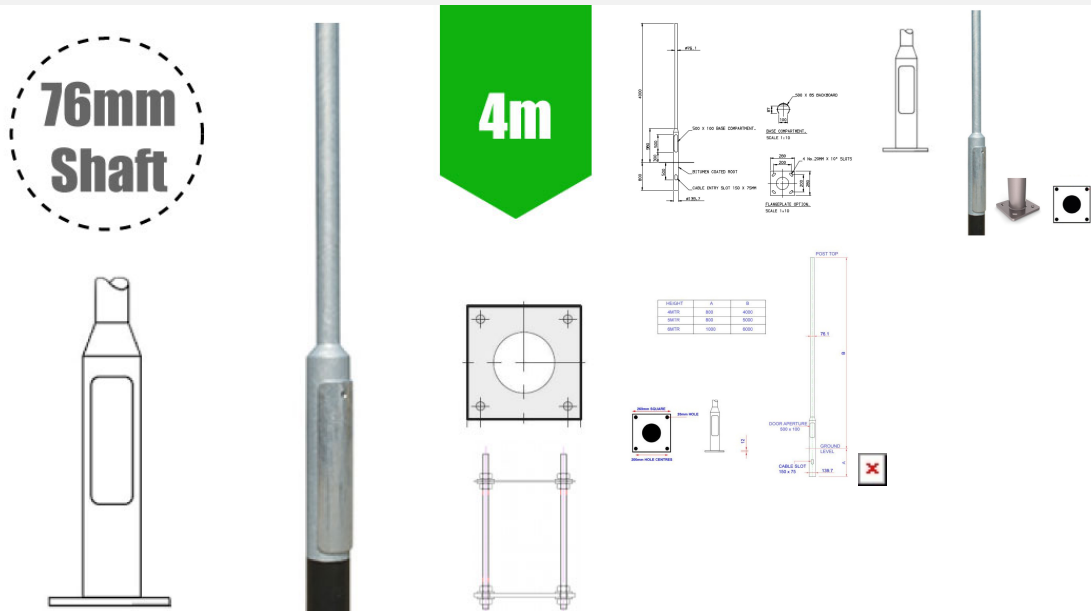







Flange Plated Lighting Column 4m (Bolt Down) - Steel Galvanised Tubular Street Lamp Post (76mm Shaft / 140mm Base) c/w with door (500mm x 100mm) and wooden backboard/ Column Weight 32kg. Maximum head load (Kg/m²) = 25 /0.5 for terrain category 3. Hot dipped galvanised. Light duty lighting column suitable for road, residential, CCTV/security features and general amenity areas, with street lanterns, floodlights & post top amenity luminaires (please see related accessories)









PLEASE NOTE - Weight & Windage must be checked for suitability of the column against the installation postcode. Please email us for more information prior to purchase. It is the responsibility of the installer to ensure columns are installed safely and correctly, no liability will be accepted by The LED Store/supplier. In certain cases a ground survey may be required prior to installation.

Requires M16 foundation bolt set & may require template for fitting - items sold separately. Unit does not include column door key. Please find the link to this product below.

[M8 COLUMN DOOR KEY](#)

| |  |  |  |  |  |  |  |  |  |
|------------|---|---|---|---|---|---|--|---|---|
| | Height Above Ground (m) | Root (Below Ground) | Base Diameter (mm) | Shaft Diameter (mm) | Base Height (mm) | Shaft Height (mm) | Max Head Weight kg/m ² | Weight (kg) | Min Concrete Diameter* (mm) |
| LST-3MCOL | 3m | 800mm | Ø140mm | Ø76mm | 1250mm | 1690mm | 40kg / 0.4 | 27kg | 950mm |
| LST-4MCOL | 4m | 800mm | Ø140mm | Ø76mm | 1250mm | 2690mm | 40kg / 0.4 | 32kg | 950mm |
| LST-5MCOL | 5m | 800mm | Ø140mm | Ø76mm | 1250mm | 3675mm | 40kg / 0.4 | 37kg | 525mm |
| LST-6MCOL | 6m | 1000mm | Ø140mm | Ø76mm | 1250mm | 4660mm | 40kg / 0.4 | 47kg | 269mm |
| LST-8MCOL | 8m | 1200mm | Ø168mm | Ø89mm | 1250mm | 6630mm | 30kg / 0.3 | 80kg | 262mm |
| LST-10MCOL | 10m | 1500mm | Ø168mm | Ø114mm | 1250mm | 8600mm | 30kg / 0.28 | 120kg | 239mm |
| LST-12MCOL | 12m | 1700mm | Ø194mm | Ø114mm | 1250mm | 9840mm | 40kg / 0.33 | 190kg | 262mm |

*Root concrete diameter based on poor soil or better, minimum 230kN/m² per m

| |  |  |  |  |  |  |  |  |  |
|-------------|---|---|---|---|---|---|---|---|---|
| | Height Above Ground (m) | Flange Plate Size (mm) | Base Diameter (mm) | Shaft Diameter (mm) | Base Height (mm) | Shaft Height (mm) | Max Head Weight kg/m ² | Weight (kg) | Concrete Dimensions* (mm) |
| LST-3MCOLFP | 3m | 280mm x 280mm | Ø140mm | Ø76mm | 1250mm | 1690mm | 40kg / 0.4 | 30kg | 700 x 700 x 800 |
| LST-4MCOLFP | 4m | 280mm x 280mm | Ø140mm | Ø76mm | 1250mm | 2690mm | 40kg / 0.4 | 32kg | 700 x 700 x 800 |
| LST-5MCOLFP | 5m | 280mm x 280mm | Ø140mm | Ø76mm | 1250mm | 3675mm | 40kg / 0.4 | 39kg | 750 x 750 x 800 |
| LST-6MCOLFP | 6m | 280mm x 280mm | Ø140mm | Ø76mm | 1250mm | 4660mm | 40kg / 0.4 | 47kg | 750 x 750 x 800 |
| LST-8MCOLFP | 8m | 320mm x 320mm | Ø168mm | Ø89mm | 1250mm | 6630mm | 30kg / 0.3 | 89kg | 850 x 850 x 900 |

*Concrete dimensions based on a minimum ground bearing pressure of 150kN/m² per m (Width x Width x Height)